

Remote AC Power Controller

MODEL PowerPort

Owner's Manual

About the PowerPort

Thank you for purchasing the Furman PowerPort Remote AC Power Controller. By installing this PowerPort you will minimize the risk of damage that can be caused by surges, faulty wiring and even lightning strikes.

An individual PowerPort provides control, timing, monitoring, and power conditioning capability for a single 20-amp circuit. All critical circuit functions are governed by an internal microprocessor.

PowerPorts may also be networked for total system control. Multiple units can be daisy-chained via low-voltage wiring to comprise the building blocks of a versatile, high performance power conditioning and distribution system. A PowerPort system can grow to any size, yet be conveniently switched on and off with either maintained or momentary contact switches using low voltage control lines.

PowerPorts offer the same power conditioning and EMI/RFI filtering as Furman's top-of-the-line PRO Series. A PowerPort will handle a whopping 11,000 amperes of spike/surge current in any mode, and will even keep itself from turning on if the voltage is below 80 volts or above 140 volts. In addition, it has independent turn-on and turn-off delays. Control wiring can be up to five miles in length without performance degradation, based on using 24 AWG wire. Other features include:

- High reliability 25 amp relays.
- Incoming voltage is monitored for acceptable levels, with marginal voltages causing flashing alerts and extreme voltages causing protective shutdown.
- Manual mode allows delays to be overridden for system diagnostics. Even in manual mode, power conditioning and extreme voltage protection are still active.
- Turn-on and turn-off delay times are screwdriver-adjustable—each can be set from 0 to 60 seconds.
- Front panel status LEDs indicate Protection OK, Ground OK, Extreme Voltage Shutdown, Mains OK, Power Status (remains on when an ON or OFF delay cycle is in progress, flashes when an abnormal condition exists) and Outlet ON.
- Rear panel terminal barrier strip provides for a number of remote control and LED monitoring options.

A PowerPort can be unobtrusively installed in the front or rear of a rack (see back page). For permanent installations, the AC cord may be removed and replaced with a standard 1/2" conduit fitting.

Safety Information

To obtain best results from your Furman PowerPort, please be sure to read this manual carefully prior to connecting it to AC. **WARNING:** The PowerPort requires that a safety ground be present for proper operation. Any attempt to operate the PowerPort without a safety ground is considered improper operation and could invalidate the warranty. Refer servicing to qualified personnel only. For Warranty and Service information, see back page.



Remote Switches and LEDS

In the most basic configuration, only two Class 1 wires and an SPST switch are needed to initiate the PowerPort's ON or OFF sequence. The switch may be either a momentary or maintained-contact type, such as the Furman RS-1 or RS-2 Remote System Control Panel. If another pair of wires is used, an LED may also be installed at the remote end to indicate that the power is on.

Maintained vs. Momentary Switching

Maintained switches, such as most toggle switches and push-on/push-off button switches (including the Furman RS-1), stay open until thrown, then stay closed until thrown again. Momentary switches, usually pushbutton types like the Furman RS-2, are normally open and stay closed only as long as the button is pressed. An on-off switch of either kind may be used to actuate the PowerPort's remote operation.

Maintained switches are generally most convenient when there is only one remote location. When more than one switch location is required, momentary switches allow the sequence to be started from any location.

PowerPorts come factory-set for maintained switch operation. They may be easily converted to momentary switch operation by moving a jumper on the circuit board:

1. Disconnect the unit from AC power.
2. Remove the four screws that secure the top cover.
3. Near the center of the circuit board there are two pairs of terminals labeled J1 MOMENTARY, and J2 MAINTAINED. Slide the jumper off of J2 and then slide it onto J1. (The functions of the J3 and J4 terminals are described in "Shutdown/Force Off Terminals" on the next page.)
4. Reattach the top cover.

The PowerPort is now set for momentary switch operation.

A simple connection of the REM IN terminal to the +12V terminal initiates an OFF sequence. Disconnecting it initiates an ON sequence. If the cable run is long, it is recommended that the REM IN wire be tied to the PowerPort's GND terminal during ON operation rather than leaving it floating. This will require the use of a third conductor and a double-throw switch.

Momentary Mode

In Momentary Mode, the PowerPort has "memory" — it only needs a momentary signal from the remote switch to change its state from ON to OFF.

When first plugged in (or after power is lost and reapplied for any reason) the "memory" state is OFF. This means the unit will be off. It will stay off until sequenced on by a momentary connection of the REM IN terminal to +12V. The sequence starts on the rising edge of the signal. The "memorized" state will track the input, so that the PowerPort will stay in synch with any other units controlled by the same remote signal.

Because it is a maintained-contact switch, the RS-1 is not an appropriate remote switch for the PowerPort when it is in momentary mode. Use the RS-2 momentary switch instead.

Front Panel Slide Switch

If the PowerPort's front panel slide switch has been moved to either OFF or ON, and then back to REMOTE, the unit will be OFF until it receives a remote actuation signal.

Status Output

The STATUS terminal is an output that may be used to illuminate an LED at the remote location to indicate that power is available at the PowerPort's outlets. If it is high (+5V), the unit is ON (or at least in the process of sequencing ON); if low, the unit is OFF (or sequencing OFF). Simply connect the indicator LED between STATUS and ground (do not use a series resistor). If the LED does not light when the switch is in the ON position, check the polarity and reverse the LED leads (if it is wrong). If a Furman RS-1 is the controlling switch, contact Furman's Tech Support department for the proper wiring diagrams.

Multiple Units

Use one PowerPort for each 20-amp circuit. To control multiple PowerPorts with one or more remote switches, connect the REM IN, +12V and GND terminals of all units together. Be sure that the mode (momentary or maintained) of all units is set the same. Connect a single maintained switch or one or more momentary switches to the PowerPort nearest the switch.

If multiple PowerPorts are controlled by one or more momentary remote switches, they will all switch at each rising edge of the voltage on the REM IN terminal. Any remote switch will toggle all the units. The slide switch on each unit's front panel will turn off that unit without affecting the other units.

The STATUS outputs work the same in either momentary or maintained mode. Each reflects the true state of the outlets of its unit, and is affected by both the "memorized" state or by the front panel slide switch. A separate LED and wire must be used to indicate the status of each PowerPort.

To take care of the special (hopefully rare) case of having several PowerPorts in parallel that somehow get out of sync such that every time a remote button is pushed, some units turn on and others turn off, there is a special feature of the remote signal line: Keeping a remote switch pushed in for at least 4 seconds will force all units to the OFF state, and put them back in sync. This is the only way to re-sync units other than disconnecting AC power to all the units. Remember — operating the front panel slide switch does NOT affect the stored state of the

unit, even though it does temporarily turn the outputs off.

Shutdown Terminal

Shutdown is a dual function terminal. It can be an INPUT or an OUTPUT. As shipped, it is an OUTPUT. An LED connected between this terminal and ground displays the same information as the PowerPort's front panel Power Status LED. This is useful for remote visual monitoring of each unit's operating status.

As an alternative, the Shutdown Terminal can be used as a Force Off INPUT. Force Off is a function that allows the PowerPort to be switched off instantly. This is useful as an emergency "kill switch". In this mode, grounding the shutdown terminal forces the unit off with no time delay. To change the Shutdown Terminal from an LED OUTPUT, to a Force Off INPUT:

1. Disconnect the unit from AC power.
2. Remove the four screws that secure the top cover.
3. Near the left rear corner of the circuit board there are two pairs of terminals labeled J3 FORCE OFF, and J4 SHUTDOWN/POWER STATUS. Slide the jumper off of J4 and then slide it onto J3.
4. Reattach the top cover.
5. Connect a remote switch or automated shutdown system between the Shutdown Terminal and ground.

Now your PowerPort is set for remote Force Off INPUT operation.

Note: If you are using the Shutdown Terminal as a Force Off INPUT, and have multiple PowerPorts connected together, be sure that all Shutdown Terminals are wired together, and that the jumpers in all units are set the same. Once the system has been forced off, it will stay off even after the Shutdown Terminal is ungrounded. To turn the PowerPort(s) back on, the Shutdown Terminal must be ungrounded and a maintained remote switch must be turned off then on again, or a momentary switch must be pushed twice. The Shutdown Terminal is pulled to +5 VDC by an Internal 10K resistor. It must be pulled down to <300 millivolts DC for at least 50 milliseconds to initiate a shutdown.

Troubleshooting

Symptom: PROTECTION OK Indicator not lit after ON delay has elapsed.
Possible Cause: Protection devices have been damaged.
Action Needed: Factory service.

Symptom: GROUND OK Indicator not lit.
Possible Cause: No building ground, bad outlet.
Action Needed: Locate good ground, run ground wire.

Symptom: OUTLET ON Indicator not lit after ON delay has elapsed.
Possible Cause: An abnormal condition exists.
Action Needed: Verify that line voltage and earth ground are okay. If both are okay, contact factory service.

Symptom: MAINS OK Indicator flashing.
Possible Cause: PowerPort is receiving either 80-90 or 130-140 volts.
Action Needed: Correct line voltage. Consider installing a Furman AR-PRO or AR-1215 voltage regulator.

Symptom: POWER STATUS Indicator flashes (and therefore power to the outlets does not switch on).
Possible Causes: (1): The input voltage is nearly out of or not within the acceptable range.
2): The front panel REMOTE (NORMAL)/ON/OFF (OVERRIDE) switch is not positioned to REMOTE (NORMAL), making the PowerPort unable to accept a remote command.
Action Needed: (1) Check and correct incoming voltage.
(2) Check the switch and make sure it is positioned to REMOTE (NORMAL).

Symptom: EXTREME VOLTAGE Indicator flashing.
Possible Cause: Input voltage is below 80 or above 140 volts, causing power to PowerPort's outlet to be shut down.

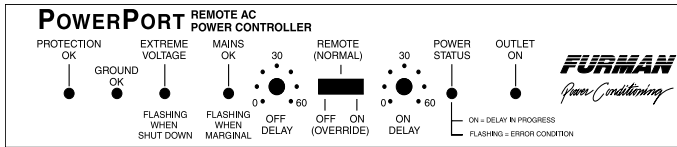

Front Panel

Front Panel Features

PROTECTION OK: This LED is normally on when the outlet is on. If an extremely large spike is encountered that exceeds the PowerPort's capacity, the main group of input protectors will blow an internal fuse, causing this indicator to go out. If LED is not lit when the outlet is on, full protection is not functioning. Spike protection may still exist, but will have a reduced capacity to absorb current. If this LED is not lit, please contact the Furman Service Department.

GROUND OK: Normally on when the outlet is on. It lights if a reasonably good safety ground exists. If this LED is not lit when the outlet is on, the unit is not properly grounded. Unplug the PowerPort and correct the ground.

EXTREME VOLTAGE SHUTDOWN: Normally off. Upon initially applying power to the PowerPort, this indicator will be lit if the inlet is receiving below 80 volts or more than 140 volts, and power will not be applied to the outlet. If the unit has been operating with an acceptable input voltage and then that voltage goes out of the acceptable range, PowerPort will shut off power to the outlet and this LED will begin flashing.

NOTE: If the mains power is below 80 volts and has caused the PowerPort to remove power from its duplex outlet, PowerPort will not restore power to the outlet until the mains voltage is more than 90 volts. If the mains power is above 140 volts and has caused the PowerPort to remove power from its outlet, PowerPort will not restore power to the outlet until the mains voltage is less than 130 volts. The reason for this is to prevent the power oscillating on and off in marginal conditions.

MAINS OK: Normally on. Indicates that power is present at the inlet. This LED will flash when input voltage is marginal (80-90 or 130-140 volts), and will be off if voltage is below 80 or above 140.

OFF DELAY: Screwdriver adjustment to select OFF time delay from 0 to 60 seconds.

REMOTE (NORMAL) SLIDE SWITCH:
(Please read this section carefully)

This three-position slide switch provides local control for diagnostics and system troubleshooting. When positioned to REMOTE, PowerPort accepts remote commands for ON/OFF control. When positioned to ON (OVERRIDE), power to the duplex outlet is switched on without the delay. When positioned to OFF (OVERRIDE), power to the outlet is switched off without delay. When the switch is in either of the override positions, PowerPort ignores external commands. Should a remote command be received by a PowerPort while switched into the ON or OFF modes, PowerPort will blink the POWER STATUS indicator. If the switch is moved from the ON position to the REMOTE position, power to the outlet is turned off until the remote is recycled once to OFF and then back ON in Maintained Mode, or push the Momentary button twice in Momentary mode. If the switch is moved from the REMOTE position to the OFF position, power will be immediately removed from the outlet.

ON DELAY: Screwdriver adjustment to set ON time delay from 0 to 60 seconds.

POWER STATUS: This LED will light and remain lit only for the duration of an ON or OFF delay sequence. It will flash continuously if either of these abnormal conditions are present: (1) The front panel slide switch is not positioned to REMOTE, making PowerPort unable to accept a remote command, and then a remote command is issued, or

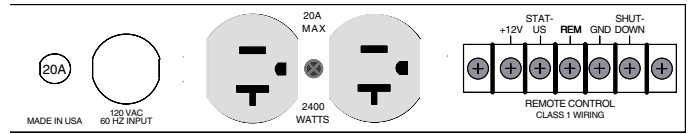

Rear Panel

2): The input voltage is not within the acceptable range.

NOTE: If an error condition occurs during any delay cycle, the power status light will flash, indicating the error condition. The delay cycle will continue.

Rear Panel Features

DUPLEX OUTLET: 20 amp max, 2400 watts, with 20 amp circuit breaker.

POWER INPUT: A 10-ft., 12 AWG power cord is provided. This power cord can be easily removed and replaced with 1/2" conduit fitting if permanent installation is desired. Here's how: First, unplug the unit. Then remove cover. Remove and retain the wire nuts from all three power cord wires (black, green, white). Squeeze the black power cord retainer (strain relief) to allow removal of the power cord. Install a 1/2" conduit fitting in the double-D power cord hole and join it to 1/2" conduit containing black, white and green 12 AWG wires. Connect the three wires (black to black, green to green, white to white) to the PowerPort, using the previously removed wire nuts. Replace cover.

TERMINAL BARRIER STRIP: Provides connection for remote control and remote monitoring. Please also refer to the Basic Remote Control Wiring diagram below.

Here is a description of each terminal barrier strip connection:

+12V: +12VDC source to be used with REM terminal to turn the PowerPort on and off.

STATUS: This terminal provides +5V output when the PowerPort outlet is on. An LED connected between this terminal and GND terminal will light and remain on as long as the outlets are on.

NOTE: Connection of remote LEDs is optional. Also, all of the remote LEDs will flash if any abnormal voltage condition exists.

REM: Selectable by using jumper J1/J2. In maintained mode, connect REM to +12V terminal to turn the PowerPort off. Leaving REM open will turn the PowerPort on. **NOTE:** For long cable run, REM should be grounded in the ON position.)

GND: For LED Status indicator ground return.

SHUTDOWN: Selectable by using Jumpers J3 and J4. This terminal can be either an input or output (shipped as output). Please read the section "Shutdown Terminal" on previous page.

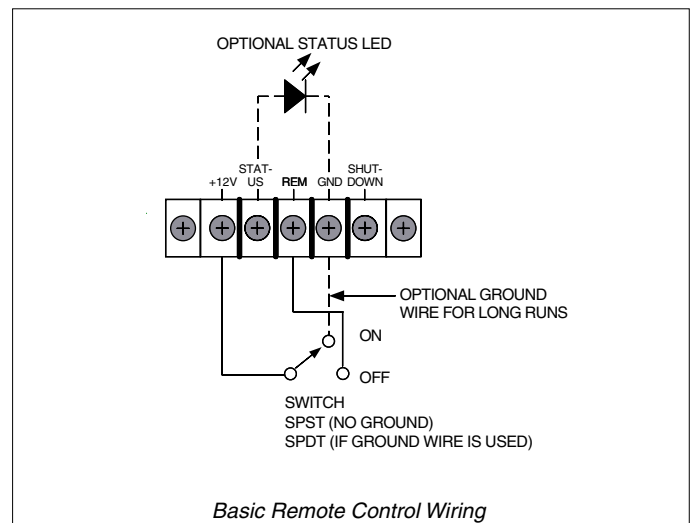

Basic Remote Control Wiring

Three Year Limited Warranty

The Furman PowerPort is warranted against failures due to defective parts or faulty workmanship for a period of three years after delivery to the original owner. During this period, Furman will make any necessary repairs without charge for parts or labor. Shipping charges to the factory or repair station must be prepaid by the owner; return shipping charges (via UPS Ground) will be paid by Furman. This warranty applies only to the original owner and is not transferable. Also, it does not apply to repairs done other than by the Furman factory or Authorized Repair Stations.



This warranty shall be cancelable by Furman at its sole discretion if the PowerPort unit has been subjected to physical abuse or has been modified in any way without written authorization from Furman. Furman's liability under this warranty is limited to repair or replacement of the defective unit. Furman will not be responsible for incidental or consequential damages resulting from the use or misuse of its products. Some states do not allow the exclusion of incidental or consequential damages, so the above limitations may not apply to you. This warranty gives you specific legal rights, and you may also have other rights which vary from state to state. Warranty claims should be accompanied by a copy of the original purchase invoice showing the purchase date (if a Warranty Registration Card was mailed in at the time of purchase, this is not necessary). Before returning any equipment for repair, please read the important information on service below.

Service

Before returning any equipment for repair, please be sure that it is adequately packed and cushioned against damage in shipment, and that it is insured. We suggest that you save the original packaging and use it to ship the product for servicing. Also, please enclose a note giving your name, address, phone number and a description of the problem.

NOTE: All equipment being returned for repair must have a Return Authorization (RA) Number. To get an RA Number, please call the Furman Service Department, (707) 763-1010, Ext. 40, between 8 am and 5 pm U.S. Pacific Time. Please display your RA Number prominently on the front of all packages.

PowerPort SPECIFICATIONS

Output Current:	20 amps (2400 watts at 120 volts AC).
Input Voltage Range:	85-264 volts AC
ON/OFF Delay Interval:	0-60 seconds (individually adjustable with trim pots).
Voltage Ranges:	Normal: 90-130. Marginal (flashes alert): 80-90 or 130-140. Extreme (causes shutdown): below 80 or above 140.
Spike Protection Modes:	Line to neutral, neutral to ground, line to ground.
Clamping Voltage:	200 volts peak.
Response Time:	1 nanosecond.
Current:	11,000 amps (8 x 20 μ S pulse).
Maximum Spike Energy:	550 joules total.
Noise Attenuation:	Differential mode: Greater than 40 dB.
Common Mode:	Greater than 60 dB, both 1 to 200 MHz.
Dimensions:	.75" H x 8.5" W x 10" D.
Weight:	6 lb. (2.7 kg).
Construction:	All construction is of powder coated steel. The front panel is 1/8" thick. The chassis is 18 gauge. Printed circuit boards are double-sided glass epoxy.
Power Consumption:	6 watts.
Agency Approvals:	UL/CSA listed. Tested to UL 1449.  

The PowerPort is designed and manufactured in the U.S.A.

POWERPORT MOUNTING KIT INSTRUCTIONS

SURFACE MOUNTING

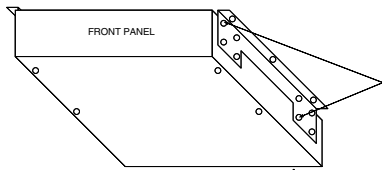

PWRKIT-1 Consists of:
 2 ea. 401104-1275 brackets
 4 ea. 860034-905 6-32 x 1/4" Phillips pan head, black oxide
 1 ea. Instruction sheet

ATTACH 1 BRACKET TO EACH SIDE, USING TWO 6-32x1/4" PHILLIPS HEAD SCREWS. BRACKETS MAY BE ATTACHED IN SUCH A WAY AS TO ALLOW MOUNTING WITH THE POWER PORT TOP OR BOTTOM AGAINST THE MOUNTING SURFACE (USUALLY THE TOP WILL BE AGAINST THE MOUNTING SURFACE, SO THE CONTROLS READ RIGHT SIDE UP). FASTEN THE BRACKETS TO THE MOUNTING SURFACE WITH APPROPRIATE FASTENERS.

SINGLE UNIT RACK MOUNT

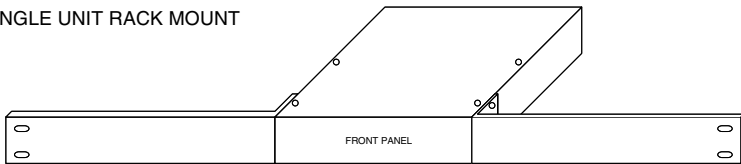

HRKIT-1

ATTACH 1 RACK EAR TO EACH SIDE, USING TWO 6-32x3/8" PHILLIPS HEAD SCREWS. FASTEN THE RACK EARS INTO THE RACK WITH APPROPRIATE FASTENERS.

DOUBLE UNIT RACK MOUNT

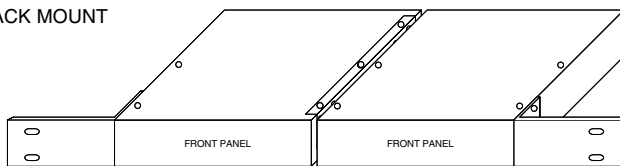

PWRKIT-2 Consists of:
 2 ea. 401104-1275 brackets
 2 ea. 410002-820 small rack ear "A"
 8 ea. 860034-905 6-32 x 1/4" Phillips pan head, black oxide
 4 ea. 860021-686 #6 x 3/8" Flathead Phillips, black oxide
 1 ea. Instruction sheet

REMOVE TWO COVER SCREWS FROM EACH POWER PORT TO BE JOINED. THE SCREWS TO BE REMOVED ARE ON THE TOP OF ONE UNIT, AND THE BOTTOM OF THE MATING UNIT, CLOSEST TO THE CENTER. ATTACH ONE-1275 BRACKET TO EACH POWER PORT, USING 6-32x1/4" PHILLIPS HEAD SCREWS, MAKING CERTAIN THAT THEY ARE MOUNTED OPPOSITE EACH OTHER. (SEE SKETCH) NEXT, INSTALL THE FOUR #6-3/8" FLATHEAD SHEET METAL SCREWS THROUGH THE HOLES IN THE BRACKETS AND THE COVERS WHILE HOLDING THE UNITS TOGETHER BY HAND. THE RACK EARS CAN BE MOUNTED NEXT. ATTACH ONE RACK EAR TO EACH SIDE, USING TWO 6-32x1/4" PHILLIPS HEAD SCREWS. FASTEN THE RACK EARS INTO THE RACK WITH APPROPRIATE FASTENERS.

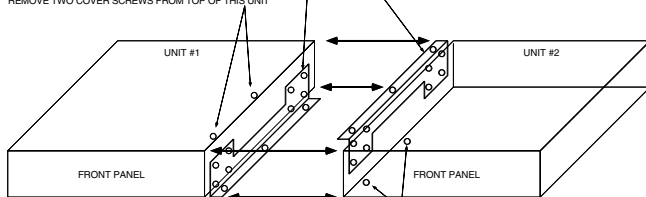

REMOVE TWO COVER SCREWS FROM BOTTOM OF THIS UNIT (NOTE: UNIT SHOWN TRANSPARENT FOR CLARITY)

Mounting Options

PowerPort can be mounted in one of three methods, each of which can be accomplished with a mounting kit from Furman. A full-size version of the PowerPort Mounting Kit Instructions shown below is included with each kit.

NOTE: Although PowerPort is half rack size, it does not conform to the HR standard, and can be mounted only to other PowerPorts for dual mounting.

SURFACE MOUNT: The PWRKIT-1 is for mounting a single PowerPort onto a flat surface, such as a wall, floor or the inside of an equipment rack, etc. The unit may be mounted so that either its top or bottom is in contact with the flat surface. The PWRKIT-1 consists of: Two each: 401104-1275 brackets. Four each: 860034-905 6-32 x 1/4" Phillips pan head screws, black oxide.

SINGLE UNIT RACK MOUNT: The HRKIT-1 is for mounting a single PowerPort into a single 19" wide rack space. The unit is centered in the rack. HRKIT-1 consists of: Two each: Rack ears, each of which attach to each side of the PowerPort, using two 6-32 x 3/8" Phillips head screws. Rack ears attach to rack with appropriate fasteners.

DOUBLE UNIT RACK MOUNT: The PWRKIT-2 is for mounting two PowerPorts, side by side, into a single 19" wide rack space. PWRKIT-2 consists of: Two each: 401104-1275 brackets. Two each: 410002-820 small rack ear "A". Eight each: 860034-905 6-32 x 1/4" Phillips pan head screws, black oxide. Four each: 860021-686 #6 x 3/8" flathead Phillips screws, black oxide.

Accessories

RS-1 AND RS-2 SYSTEM CONTROL PANELS: Switches that mount in any standard electrical switch box, for use with PowerPorts, MiniPorts, PowerLinks, ASD-120 Sequenced Power Distros, PS-8R or PS-PRO Power Sequencers. The RS-1 is a maintained contact switch; the RS-2 uses a momentary contact. Both feature a locking switch with a removable key, and have LEDs for Status and Outlet On. All wiring is via a screw terminal strip.

MINIPOINT-15 and MINIPOINT-20 POWER RELAYS: Low-cost 15A and 20A relay switched outlets, suitable for remote control via low voltage wiring. Both models are similar in appearance. Both include 12 VDC power supply, delay features and knockout holes for 1/2" conduit.



RS-1, RS-2



MiniPort-20